

TYPE: **UI30/16,5-ZA**

NOMINAL POWER: **10 VA**

- According to EN 61558-2-6
- Two compartments bobbins
- Insulation class T 70/B
- Insulation voltage 4 kV
- Potted under vacuum
- 100 % tested production
- Weight 240 g

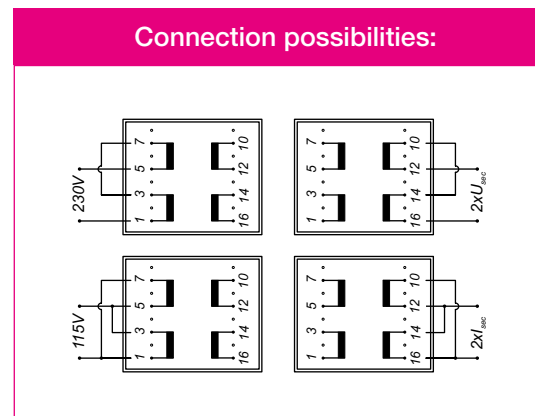
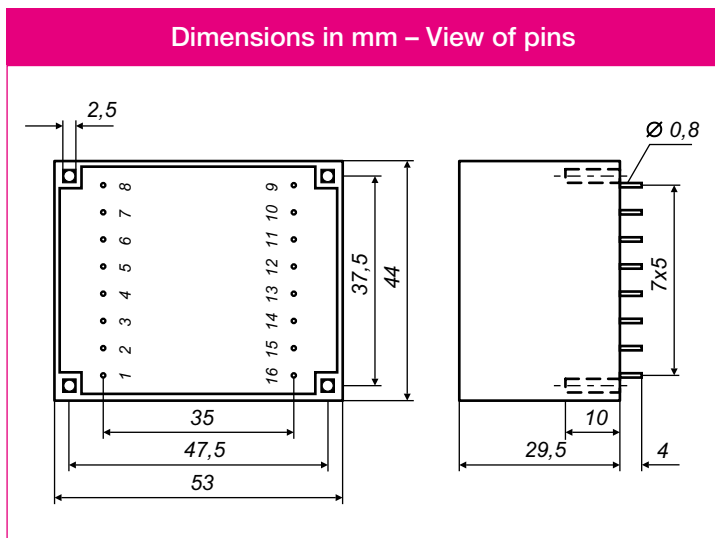

Recommended drill – hole for pins 1,3 mm.
Recommended drill – hole for mountings 4 mm.
Fixing with sheet-metal screws (2,9 x L DIN 7971).

Art. number	Primary voltage V	Pins	Secondary voltage V	Secondary current mA	No load voltage V	Pins	Secondary protection mA
322030	2 x 115	1-3 / 7-5	2 x 6	2 x 833	2 x 7,7	10-12 / 16-14	63 / 125
322036	2 x 115	1-3 / 7-5	2 x 7,5	2 x 666	2 x 9,4	10-12 / 16-14	63 / 125
322031	2 x 115	1-3 / 7-5	2 x 9	2 x 555	2 x 11,5	10-12 / 16-14	63 / 125
322032	2 x 115	1-3 / 7-5	2 x 12	2 x 416	2 x 14,8	10-12 / 16-14	63 / 125
322033	2 x 115	1-3 / 7-5	2 x 15	2 x 333	2 x 18,4	10-12 / 16-14	63 / 125
322034	2 x 115	1-3 / 7-5	2 x 18	2 x 277	2 x 22,2	10-12 / 16-14	63 / 125
322035*	2 x 115	1-3 / 7-5	2 x 21	2 x 238	2 x 29,5	10-12 / 16-14	63 / 125

Other voltages, currents, pin configurations and temperature classes on request.
 Specifications subject to change without notice.

* Note: product not according to EN 61558-2-6.